

FLUSSO REGOLABILE  
ADJUSTABLE FLOW

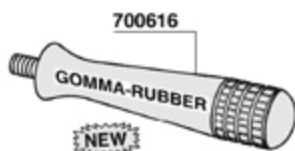

GR2-3 V220	620712 _GICAR	9.5.14.59 00	9.5.14.60 00
	620712/1 _GICAR	9.5.14.59 01	9.5.14.60 01
	620712/2 _GICAR	9.5.14.59 02	9.5.14.60 02
	620712/3 _GICAR	9.5.14.59 03	9.5.14.60 03

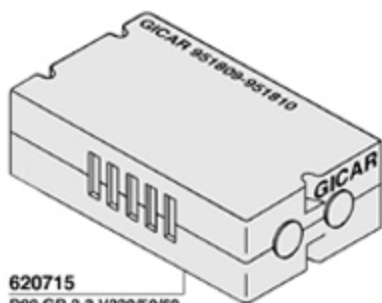



**620715**  
D90 GR.2-3 V230/50/60



**401920**



**401920**

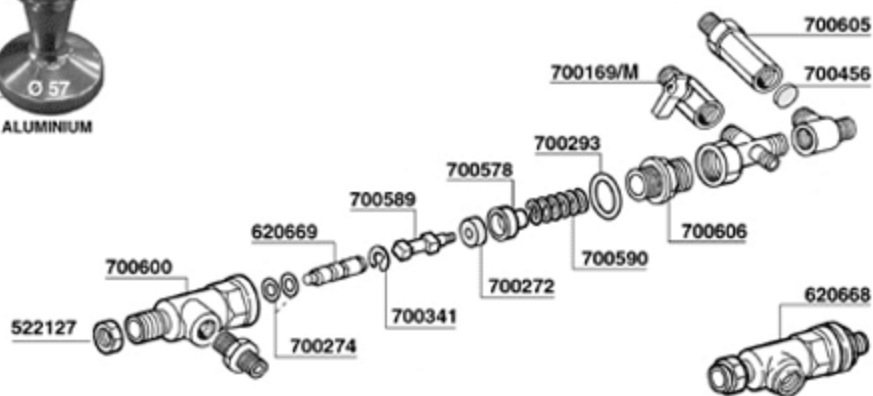
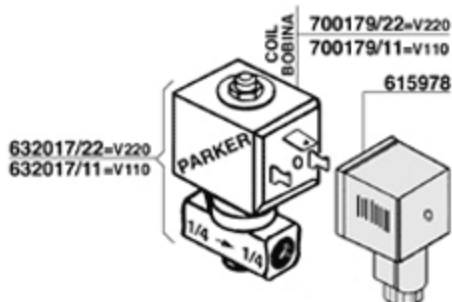

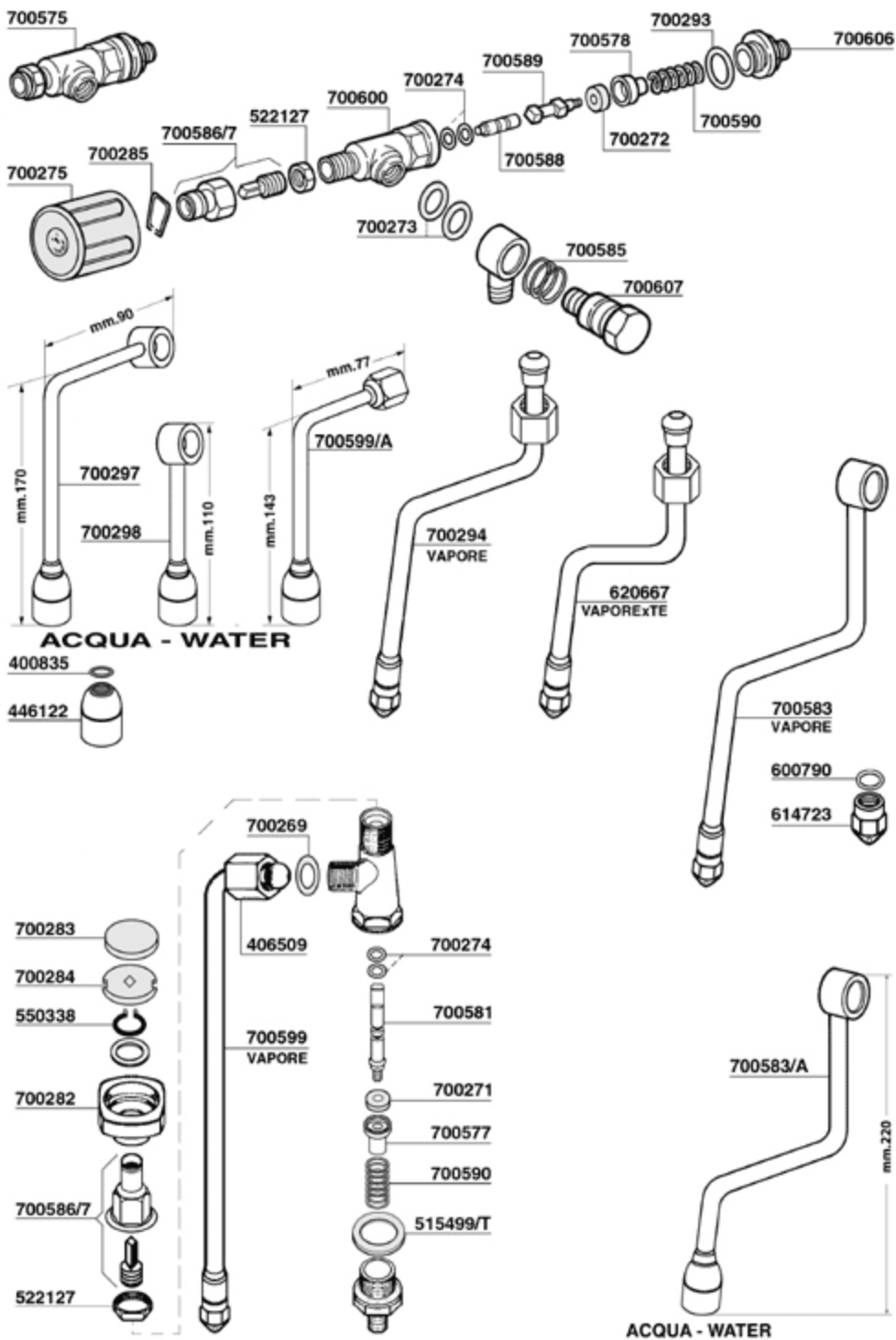

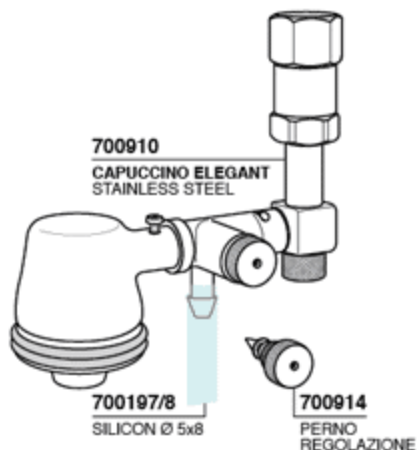
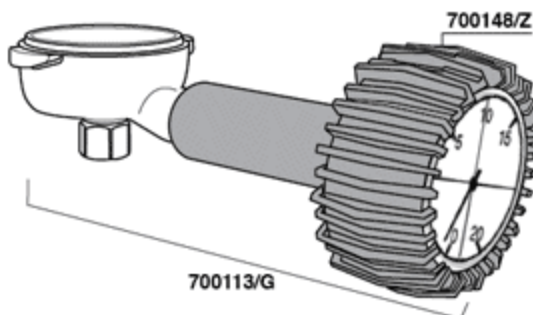
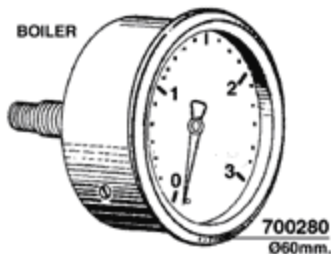
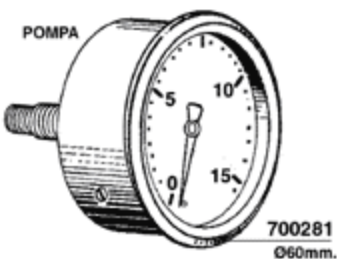
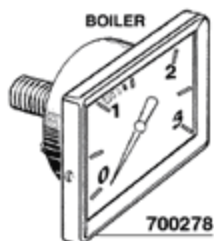
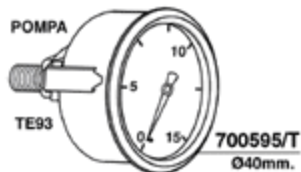
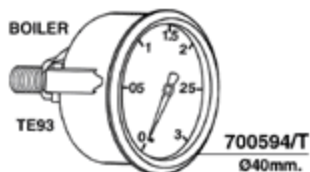
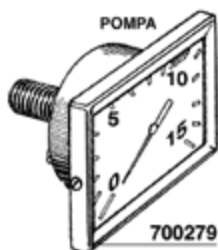
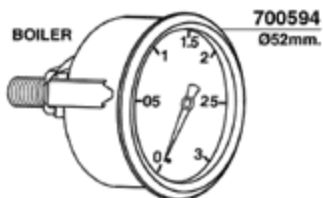
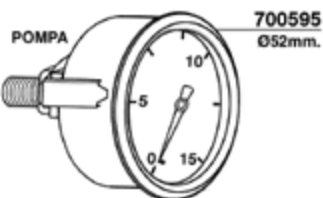

**616597/UL USA**



ASSO



700267  
700267/T=TEFLON

700569

700592=CAFFE'  
W1500 V220/380

700593=VAPORE  
W2000 V220/380

ASSO



700591

ASSO



700571

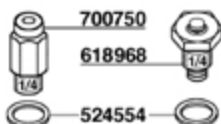

700750

618968

524554

700268

524556

310450=XD GR2 W4000 V220/380 310mm

310451=XD GR3 W5000 V220/380 400mm

700566=W2500 V220/380 215mm

TE-TD GR2



700570

401368  
O-RING

591668



700266

TELL

700260/22=GR/1 W750 V220

700261/22=GR/2 W1250 V220

700262/22=GR/3 W1750 V220

545089

700597

700597/T=TEFLON

700570



700596

700263=GR/1 W2500 V220/380

700264=GR/2 W4000 V220/380

700265=GR/3 W5000 V220/380

700569

ELE

700570

700267

700267/T=TEFLON

